



SPECIFICATION

宏致電子股份有限公司

桃園縣中壢市東園路13號

No.13, Dongyuan Rd., Zhongli City,

Taoyuan County 320, Taiwan (R.O.C.)

TEL: +886-3-463-2808

FAX: +886-3-463-1800

SPEC. NO.: PS-50523-XXXXX-XXX REVISION: D

PRODUCT NAME: 1.0mm PITCH EASY ON FPC CONN.

PRODUCT NO: 50523-XXXXX-XXX. 50524-XXXXX-XXX.
50692-XXXXX-XXX

PREPARED: XUFEI DATE: 2014/01/15	CHECKED: JERRY DATE: 2014/01/15	APPROVED: JASON DATE: 2014/01/15
---	--	---



TITLE: **1.0mm PITCH EASY ON FPC CONN.**

RELEASE DATE: 2014.01.15

REVISION: D

ECN No: ECN-1401253

PAGE: **2** OF **11**

1	REVISION HISTORY.....	3
2	SCOPE	4
3	APPLICABLE DOCUMENTS.....	4
4	REQUIREMENTS.....	4
5	PERFORMANCE	5
6	INFRARED REFLOW CONDITION	8
7	PRODUCT QUALIFICATION AND TEST SEQUENCE.....	9
8	FPC RETENTION FORCE	10
9	INSTRUCTION UPON USAGE.....	11

TITLE: **1.0mm PITCH EASY ON FPC CONN.**

RELEASE DATE: 2014.01.15

REVISION: D

ECN No: ECN-1401253

PAGE: **3** OF **11**

1 Revision History

Rev.	ECN #	Revision Description	Prepared	Date
O	ECN-0811117	NEW SPEC	JASON	2008/11/17
A	ECN-1009060	REVISED SPEC	HUANTY	2010/10/10
B	ECN-1105163	ADD NEW PROJECTS - 50692 SERIES	SHM	2011/05/09
C	ECN-1210016	REVISED FPC RETENTION FORCE SERIES	TANGENGHUI	2012/11/05
D	ECN-1401253	ADD WORKING VOLTAGE	XUFEI	2014/01/15

TITLE: **1.0mm PITCH EASY ON FPC CONN.**

RELEASE DATE: 2014.01.15

REVISION: D

ECN No: ECN-1401253

PAGE: 4 OF 11

2 SCOPE

This specification covers performance, tests and quality requirements for **1.0mm PITCH EASY ON FPC CONN**

3 APPLICABLE DOCUMENTS

EIA-364: ELECTRONICS INDUSTRIES ASSOCIATION

4 REQUIREMENTS

4.1 Design and Construction

- 4.1.1 Product shall be of design, construction and physical dimensions specified on applicable product drawing.
- 4.1.2 All materials conform to R.o.H.S. and the standard depends on TQ-WI-140101.

4.2 Materials and Finish

- 4.2.1 Contact: High performance copper alloy (Phosphor Bronze)
Finish: (a) Contact Area: Refer to the drawing.
(b) Under plate: Refer to the drawing.
(c) Solder area: Refer to the drawing.
- 4.2.2 Housing: Thermoplastic or Thermoplastic High Temp., UL94V-0
- 4.2.3 Actuator: Thermoplastic or Thermoplastic High Temp., UL94V-0
- 4.2.4 Fitting Nail: Copper Alloy, Finish: Refer to the drawing.

4.3 Ratings

- 4.3.1 Working voltage less than 36 volts (per pin)
- 4.3.2 Voltage: 50 Volts AC (per pin)
- 4.3.3 Current: 1.0 Amperes (per pin)
- 4.3.4 Operating Temperature : -40°C to +85°C

TITLE: **1.0mm PITCH EASY ON FPC CONN.**

RELEASE DATE: 2014.01.15

REVISION: D

ECN No: ECN-1401253

PAGE: 5 OF 11

5 Performance

5.1. Test Requirements and Procedures Summary

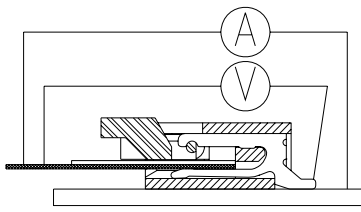
Item	Requirement	Standard
Examination of Product	Product shall meet requirements of applicable product drawing and specification.	Visual, dimensional and functional per applicable quality inspection plan.
ELECTRICAL		
Item	Requirement	Standard
Low Level Contact Resistance	55 m Ω Max. per contact 20 m Ω Max. Change allowed	Mate connectors, measure by dry circuit, 20mV Max., 100mA Max.  (EIA-364-23)
Insulation Resistance	500 M Ω Min.	Unmated connectors, apply 500 V DC between adjacent terminals. (EIA-364-21)
Dielectric Withstanding Voltage	No discharge, flashover or breakdown. Current leakage: 2 mA max.	250 VAC Min. at sea level for 1 minute. Test between adjacent contacts of unmated connectors. (EIA-364-20)
Temperature Rise	30°C Max. Change allowed	Mate connector: measure the temperature rise at rated current until temperature stable. The ambient condition is still air at 25°C (EIA-364-70, METHOD1,CONDITION1)

TITLE: **1.0mm PITCH EASY ON FPC CONN.**

RELEASE DATE: 2014.01.15

REVISION: D

ECN No: ECN-1401253

PAGE: **6** OF **11**

MECHANICAL		
Item	Requirement	Standard
Durability	30 cycles.	The sample should be mounted in the tester and fully mated and unmated the number of cycles specified at the rate of 25.4 ± 3 mm/min. (EIA-364-09)
FPC Retention Force	Refer to page.10 FPC retention force	A connector shall be soldered on a board and insert the actuator, pull the FPC at the speed rate of 25.4 ± 3 mm/min.
Terminal /Housing Retention Force	0.2kgf MIN.	Operation Speed : 25.4 ± 3 mm/minute. Measure the contact retention force with tester.
Fitting Nail /Housing Retention Force	0.2kgf MIN.	Operation Speed : 25.4 ± 3 mm/minute. Measure the contact retention force with tester.
Vibration	1 μs Max.	The electrical load condition shall be 100 mA maximum for all contacts. Subject to a simple harmonic motion having amplitude of 0.76mm (1.52mm maximum total excursion) in frequency between the limits of 10 and 55 Hz . The entire frequency range, from 10 to 55 Hz and return to 10 Hz , shall be traversed in approximately 1 minute. This motion shall be applied for 2 hours in each of three mutually perpendicular directions. (EIA-364-28 Condition I)
Shock (Mechanical)	1 μs Max.	Subject mated connectors to 50 G's (peak value) half-sine shock pulses of 11 milliseconds duration. Three shocks in each direction shall be applied along the three mutually perpendicular axes of the test specimen (18 shocks). The electrical load condition shall be 100mA maximum for all contacts. (EIA-364-27, test condition A)

TITLE: **1.0mm PITCH EASY ON FPC CONN.**

RELEASE DATE: 2014.01.15

REVISION: D

ECN No: ECN-1401253

PAGE: 7 OF 11

ENVIRONMENTAL

Item	Requirement	Standard
Resistance to Wave Soldering Heat	See Product Qualification and Test Sequence Group 10 (Lead Free)	Solder Temp. : 265±5°C, 10±0.5sec.
Resistance to Reflow Soldering Heat	See Product Qualification and Test Sequence Group 10 (Lead Free)	Pre Heat : 150°C~180°C, 60~120sec. Heat : 230°C Min., 40sec Min. Peak Temp. : 260°C Max, 10sec Max.
Thermal Shock	See Product Qualification and Test Sequence Group 4	Mate module and subject to follow condition for 5 cycles. 1 cycles: -55 +0/-3 °C, 30 minutes +85 +3/-0 °C, 30 minutes (EIA-364-32, test condition I)
Humidity	See Product Qualification and Test Sequence Group 4	Mated Connector 40°C, 90~95% RH, 96 hours. (EIA-364-31, Condition A, Method II)
Temperature Life	See Product Qualification and Test Sequence Group 5	Subject mated connectors to temperature life at 85°C for 96 hours . (EIA-364-17, Test condition A)
Salt Spray (Only For Gold Plating)	See Product Qualification and Test Sequence Group 6	Subject mated/unmated connectors to 5% salt-solution concentration, 35°C (I) Gold flash for 8 hours (II) Gold plating 5 u" for 96 hours. (EIA-364-26)
Solder ability	Tin plating: Solder able area shall have minimum of 95% solder coverage. Gold plating: Solder able area shall have minimum of 75% solder coverage	And then into solder bath, Temperature at 245 ±5°C , for 4-5 sec. (EIA-364-52)
Hand Soldering Temperature Resistance	Appearance: No damage	T ≥ 350°C, 3sec at least.

Note. Flowing Mixed Gas shall be conduct by customer request.

TITLE: **1.0mm PITCH EASY ON FPC CONN.**

RELEASE DATE: 2014.01.15

REVISION: D

ECN No: ECN-1401253

PAGE: **8** OF **11**

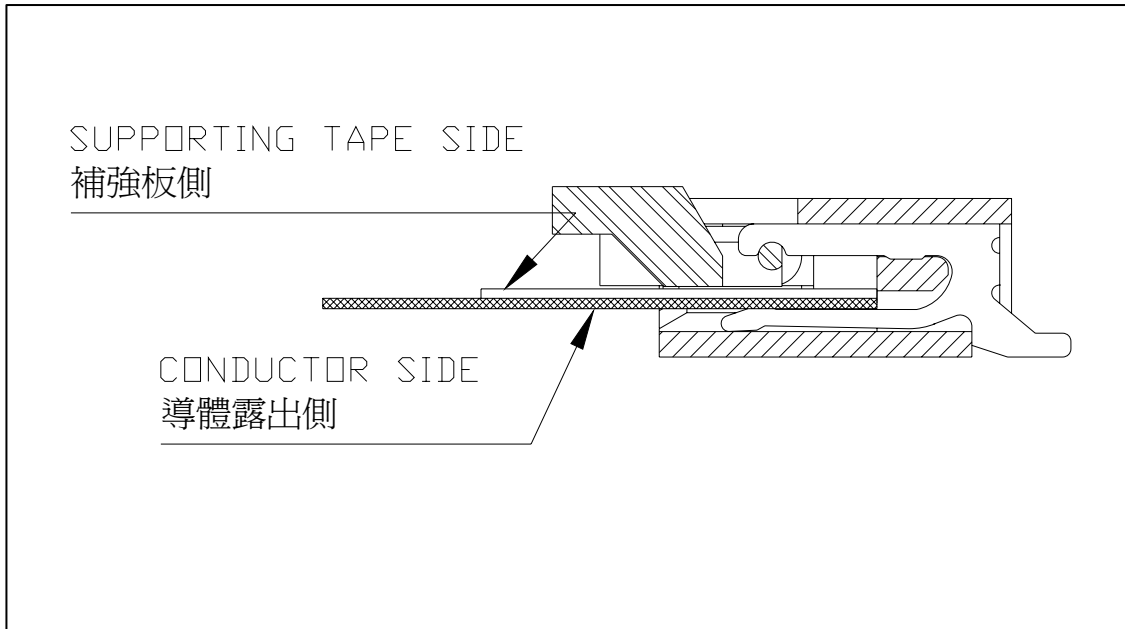

6 INFRARED REFLOW CONDITION

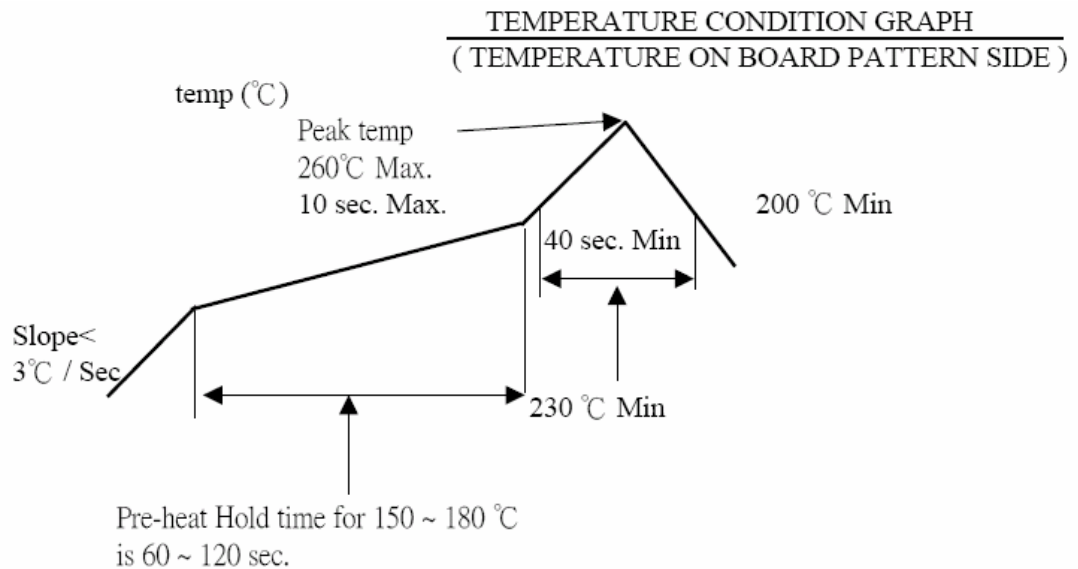

TITLE: **1.0mm PITCH EASY ON FPC CONN.**

RELEASE DATE: 2014.01.15

REVISION: D

ECN No: ECN-1401253

PAGE: 9 OF 11

7 PRODUCT QUALIFICATION AND TEST SEQUENCE

Test or Examination	Test Group										
	1	2	3	4	5	6	7	8	9	10	11
	Test Sequence										
Examination of Product				1、7	1、6	1、4				1	1
Low Level Contact Resistance		1、5	1、4	2、10	2、9	2、5				3	
Insulation Resistance				3、9	3、8						
Dielectric Withstanding Voltage				4、8	4、7						
Temperature Rise	1										
Durability		3									
Vibration			2								
Shock (Mechanical)			3								
Thermal Shock				5							
Humidity				6							
Temperature Life					5						
Salt Spray(Only For Gold Plating)						3					
Solder ability							1				
FPC Retention Force		2、4									
Terminal / Housing Retention Force									1		
Fitting Nail /Housing Retention Force									2		
Resistance to Soldering Heat										2	
Hand Soldering Temperature Resistance											2
Sample Size	2	4	4	4	4	4	2	4	4	4	4

TITLE: **1.0mm PITCH EASY ON FPC CONN.**

RELEASE DATE: 2014.01.15

REVISION: D

ECN No: ECN-1401253

PAGE: **10** OF **11**

8 FPC RETENTION FORCE

UNIT: Kgf

NO. OF Ckt.	FPC Retention Force (Min)
4	0.20
5	0.25
6	0.30
7	0.35
8	0.40
9	0.45
10	0.50
11	0.55
12	0.60
13	0.65
14	0.70
15	0.75
16	0.80
17	0.85
18	0.90
19	0.95
20	1.00
21	1.05
22	1.10
23	1.15
24	1.20
25	1.25
26	1.30
27	1.35
28	1.40
29	1.45
30	1.50
31	1.55
32	1.60
33	1.65
34	1.70

TITLE: **1.0mm PITCH EASY ON FPC CONN.**

RELEASE DATE: 2014.01.15

REVISION: D

ECN No: ECN-1401253

PAGE: 11 OF 11

9 INSTRUCTION UPON USAGE

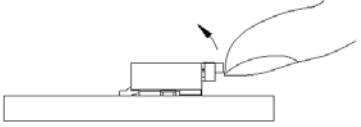
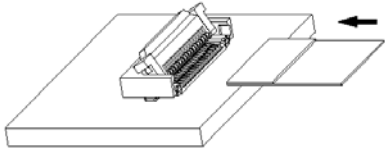
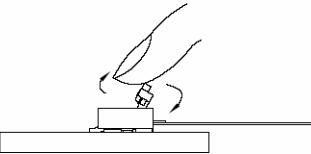
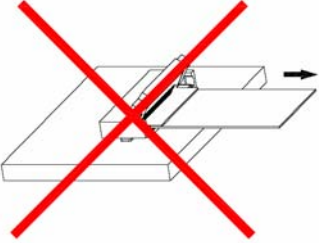
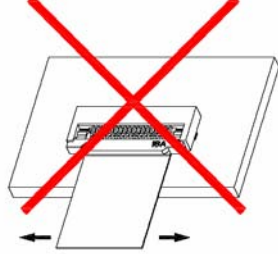
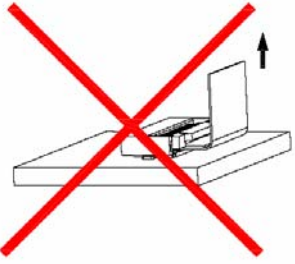
Operation	Precautions
<p>FPC/FFC Termination procedure. Connector installed on the board.</p> <p>1) Lift up the actuator. Use thumb or index finger.</p>  <p>2) Do with the actuator opened completely, and insert it in the interior of the insertion entrance surely when you insert FPC/FFC. There are some insertion resistance because this connector has the FPC/FFC temporary retention mechanism.</p>  <p>3) Rotate down the actuator until firmly closed. It is critical that the inserted FPC/FFC is not moved and remains fully inserted. Should the FPC/FFC be moved, open the actuator and repeat the process, starting with Step 1 above.</p> 	<p>1) Do when you pull out mating FPC/FFC with the Actuator opened completely. Confirm whether to Have adhered to the terminal contact part before FPC/FFC is mated with the connector housing when the opening of the actuator is the un-complete and FPC/FFC is pulled out.</p>  <p>2) Do not add the load mating FPC/FFC with connector housing.</p>  <p>3) Due to the structure of the connectors, they do not have string resistance to upward pulling; therefore, support the FPC/FFC when a pulling force is applied to it.</p> 
<p>FPC/FFC Removal</p> <p>1) Lift up the actuator.</p> <p>2) Carefully remove the FPC/FFC.</p> 