

A B C D E F G H I J

1
2
3
4
5
6
7

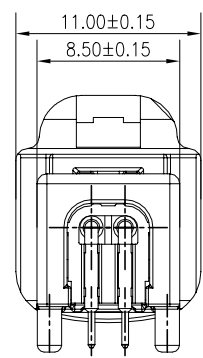
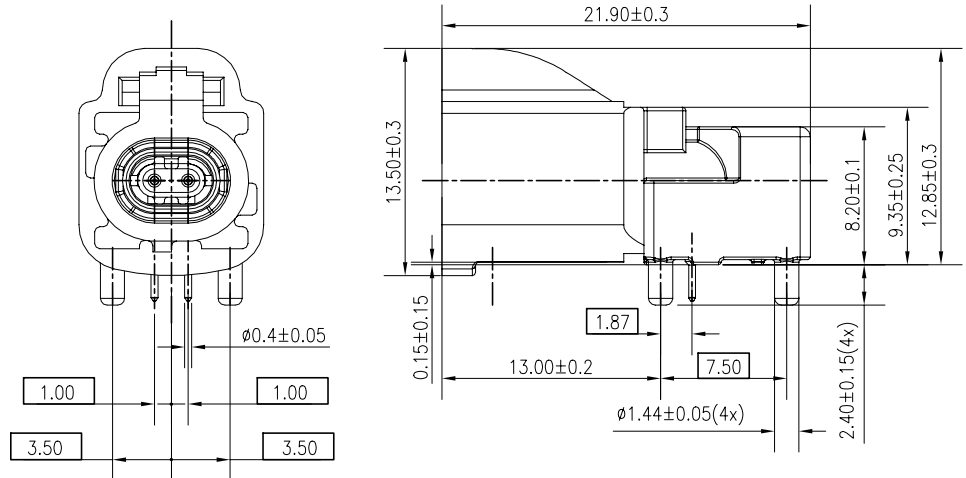
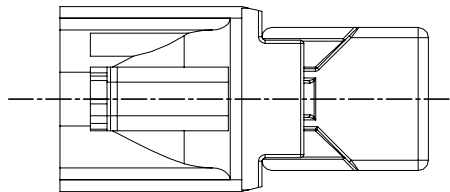

- NOTES:
- MATERIAL:
 - HOUSING: PA9T
 - DIELECTRIC: LCP
 - SHELL: ZAMAK3
 - CONTACT: BRASS
 - FINISH

CONTACT:

CONTACT:SEE ORDER INFORMATION

UNDERPLATING:50~100u" NICKEL OVERALL

SHELL:120u"~240u" MATTE TIN
 - ELECTRICAL DATA:
 - IMPEDANCE: 100Ω
 - FREQUENCY: DC to 10GHz
 - RETURN LOSS: ≥30dB, 0.01GHz to 3GHz;
≥25dB, 3GHz to 6GHz;
≥20dB, 6GHz to 10GHz;
 - SPEC. PLS. REFER TO PS 92806-XXXX-XXX
 - PACKAGE PLS. REFER TO 92806-001CR-U
 - PART NUMBER

92806-001 X X -CAX

CKTS

PACKING

0:TAPE & REEL

PLATING

8: 6u" GOLD

Coding:
X:REFERENCE ON
Page.2 TABLE

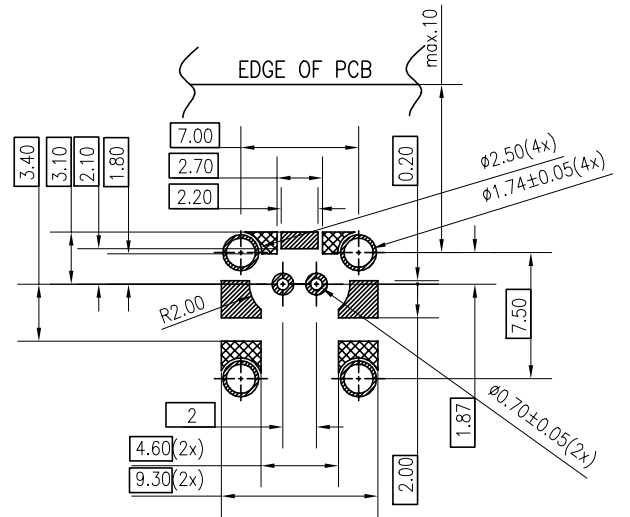

Solder Area

Keep out Area

RECOMMENDED PCB LAYOUT
GENERAL TOLERANCE ±0.05

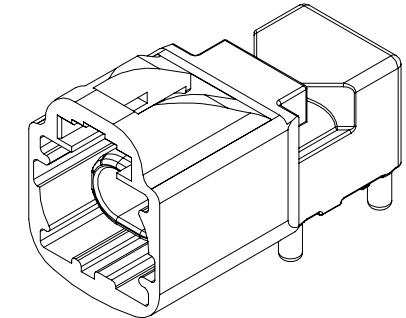



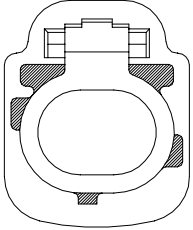
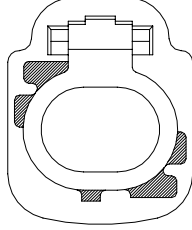
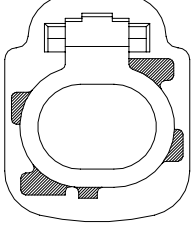
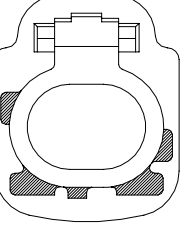
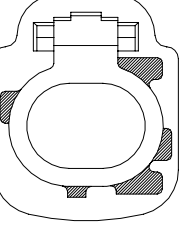
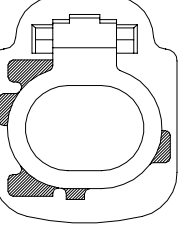
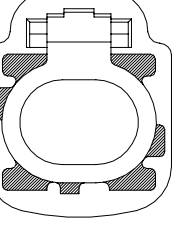
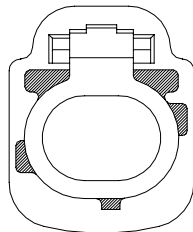
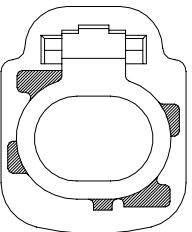
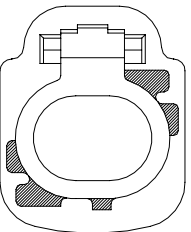
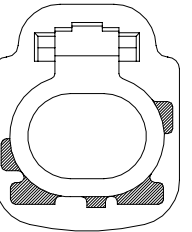
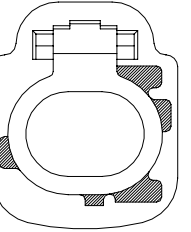
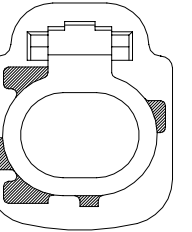
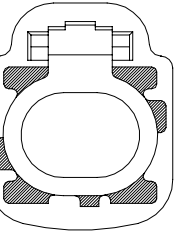

QUALITY SYMBOLS MAJOR CRITICAL GENERAL TOLERANCES (UNLESS SPECIFIED) X. ±0.15 .X ±0.10 .XX ±0.05 .XXX ±0.02 ANGLES ±1°	DRAWN BY CHUNG Ping Chang 21/04/19	DATE 21/04/19		TITLE H-AMTD PCB PLUG RIGHT ANGLE SINGLE	
	CHECKED BY LEE Kuang En 21/04/19	DATE 21/04/19			
	APPROVED BY CHEN Chi Chang 21/04/19	DATE 21/04/19	UNITS mm	SIZE A4	RFQ NO. NA
	SCALE 1 : 1	SHEET NO. 1 OF 1	REV B	DWG NO. 92806-001XX-XXX	

B C D E F G H I J

TABLE for Coding:

Coding	A	B	C	D	E	F	Z
Plug							
Color	Jet Black	Pure White	Light Blue	Claret Violet	May Green	Nut Brown	Water Blue
RAL	sim.9005	sim.9010	sim.5012	sim.4004	sim.6017	sim.8011	sim.5021
Coding	G	H	J	K	L	M	O
Plug							
Color	Platinum Grey	Light Pink	Beige	Curry	Yellow Green	Pastel Orange	Light Green
RAL	sim.7036	sim.3015	sim.1001	sim.1027	sim.6018	sim.2003	sim.6027

QUALITY SYMBOLS MAJOR  CRITICAL  GENERAL TOLERANCES (UNLESS SPECIFIED) X. ±0.15 .X ±0.10 .XX ±0.05 .XXX ±0.02 ANGLES ±1°	DRAWN BY CHUNG Ping Chang 21/04/19	DATE 21/04/19		
	CHECKED BY LEE Kuang En 21/04/19	DATE 21/04/19		TITLE H-AMTD PCB PLUG RIGHT ANGLE SINGLE
	APPROVED BY CHEN Chi Chang 21/04/19	DATE 21/04/19	SIZE A4	RFQ NO. NA
	UNITS mm		SCALE 1 : 1	SHEET NO. 2 OF 2
		REV B	DWG NO. 92806-001XX-XXX	