

A B C D E F

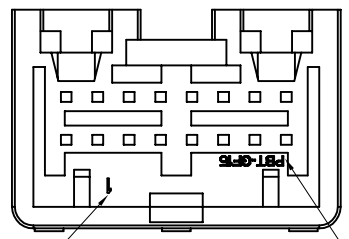

CAV. MATERIAL OF PLASTIC

- NOTES:
- MATERIAL:
 - MATERIAL: PBT,UL 94-HB,COLOR IS NATURAL.(WHITE)
 - CONTACT: BRASS
 - FINISH:
 - 10u" Min. NICKEL PLATING OVERALL
 - 50u" Min. Tin PLATING OVERALL
 - THE CAVITY, LOGO MAX HEIGHT 0.10mm ABOVE SURFACE. THE TEXT HEIGHT IS ABOUT 1mm.
 - IF ANY DIMENSIONS OR DRAFT ANGLES WEREN'T MARKED, PLS. REFER TO 3D DRAWING
 - RECOMMENDED SCREW: PAN-HEADED, TAPPING SCREW OF DIA 3mm, LENGTH: SEE TABLE A
 - SPEC. PLS. REFER TO SPEC-91235-XXXX
 - PACKAGE PLS. REFER TO 91235-016XX-TRAY
 - PART NUMBER

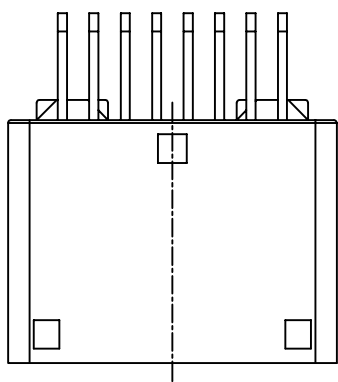
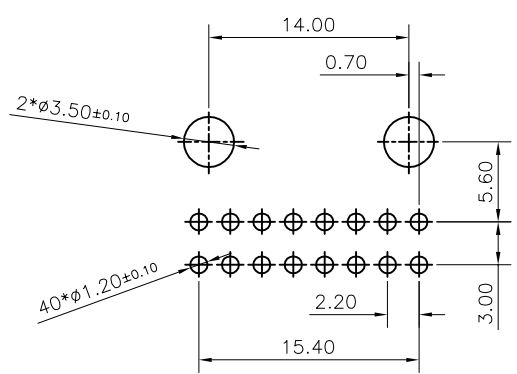
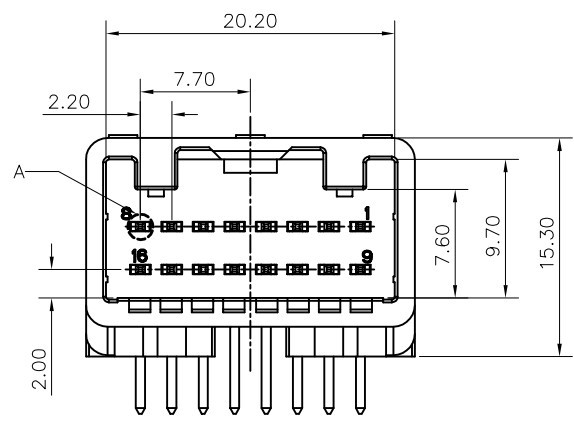

91235-016 X X - CA1

NO OF CKT ———— PLATING
 PACKING ———— 3: PURE TIN(LEAD FREE)
 1:TUBE
 2:TRAY

8. DATE CODE 編碼原則: 91235-016XX-CA1 廠別代碼:
 0 A 08 T T=TW-台灣
 年分代碼:0=2010年 D=DG-東莞
 月份代碼:A(1月),B(2月)... E=KS-昆山長江廠
 日期代碼:8=08號 K=KS-昆山青陽廠
 廠別代碼: G=CG-重慶
 重工品代碼:"&"_"非重工品代碼為空白

RECOMMEND PCB LAYOUT
 GENRAL TOLERANCE±0.05

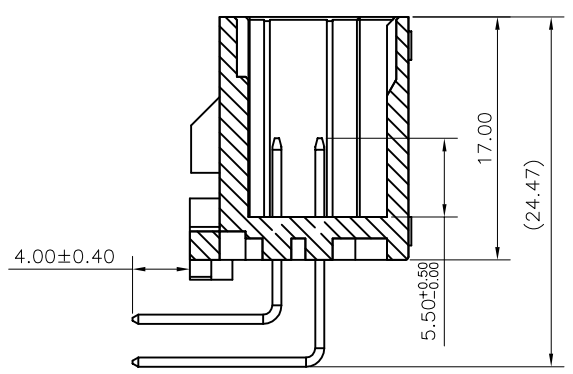
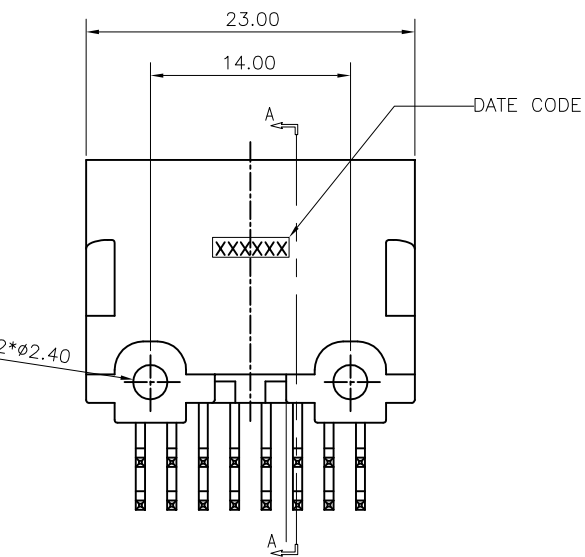
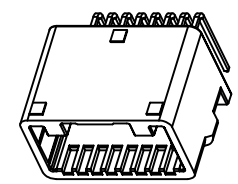
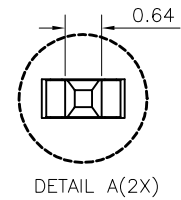

SECTION A-A

TABLE A

PCB THICKNESS (mm)	1.2	1.6
NOMINAL LENGTH OF SCREW(mm)	5	6

一般公差 TOLERANCES X ±0.5 XX ±0.15 X ±0.25 XXX ±0.10 ANGLES ±2°		宏致電子股份有限公司 Aces Electronics Co.,Ltd.	
檢驗尺寸標示 SYMBOLS (M) (L) INDICATE CLASSIFICATION DIMENSION (M) MARK IS CRITICAL DIM. (L) MARK IS MAJOR DIM.	品名 (TITLE) 2.2MM PITCH WT B WAFER CONN.	製圖 (DR) 17/08/14 審核 (CHKD) Lee Kuang En	5
表面處理 (FINISH)	圖號 (DWG.NO) 91235-016XX-CA1	核准 (APPD) Lee Kuang En	
	比例 (SCALE) 單位 (UNITS) 2:1 mm	張數 (SHEET) SIZE REV 1 OF 2 A4 C	

A B C D E F