

RoHS 2.0+HF

| REV. | DESCRIPTION | DESIGN | DATE |
|------|---------------|-----------|------------|
| A | First Drawing | Luyao.Liu | 2023/08/03 |

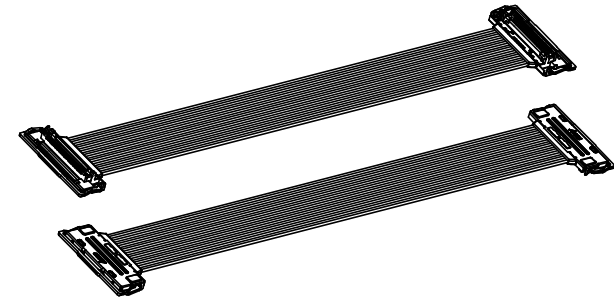

Cable spec.
This specification covers UL recognized PFA insulated wire for internal wiring of electronic equipment.
[UL style 1354/80°C,30V]

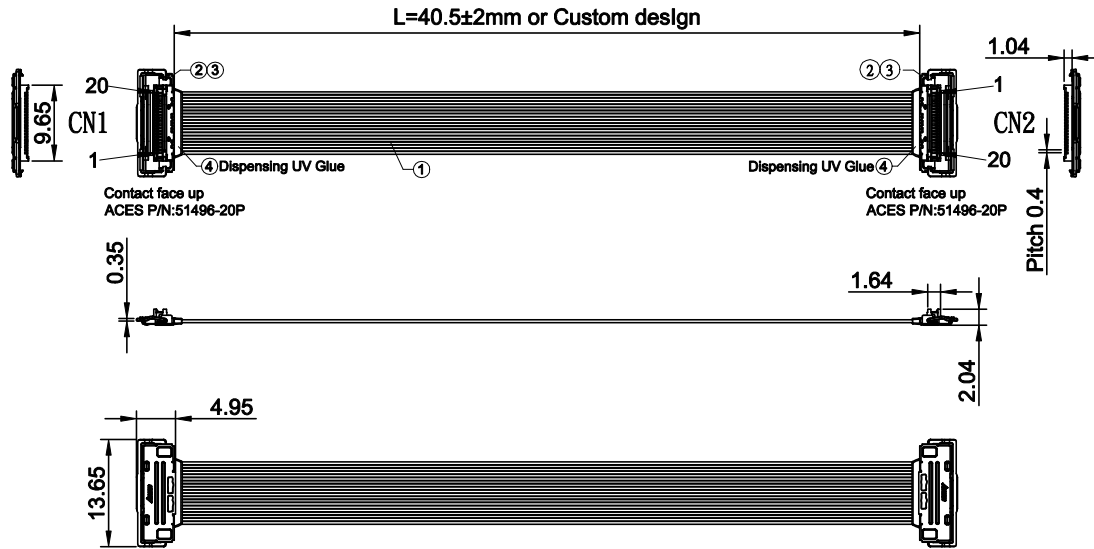
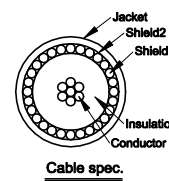

| 1. Construction | | | | | |
|-----------------|---------------------|--------|------------------------------|---|------|
| Inner conductor | AWG | — | 40 | | |
| | Material | — | Tinned copper Alloy | | |
| | Construction | No./mm | 7/0.03±0.003 | | |
| | Pitch | mm | S P=1.0-2.0 | | |
| Insulation | Dia.(approx) | mm | 0.09±0.01 | | |
| | Material | — | PFA | | |
| | Norm. Thickness | mm | 0.075 | | |
| | Min. Thickness | mm | 0.060 | | |
| Shield 1 | Dia.(approx) | mm | 0.24±0.02 | | |
| | Material | — | White | | |
| | Construction | — | Tinned copper Alloy | | |
| | The number of metal | pcs | 28±2 | | |
| Shield 2 | Pitch | mm | 4.8±0.05 | | |
| | Material | — | Cu metallized polyester tape | | |
| | Overlapping | % | ≥80 | | |
| | Construction | — | Wrapping | | |
| Jacket | Material | — | PET | | |
| | Construction | — | Wrapping | | |
| | Norm. Thickness | mm | 0.01 | | |
| | Dia.(approx) | mm | 0.35±0.02 | | |
| Color | | | | — | Blue |

| 2.Characteristics | | |
|--------------------------------------|--------------------|----------|
| Item | Unit | Spec. |
| Rated temperature | ℃ | 80 |
| Rated voltage | V | 30 |
| Max. conductor resistance at 20°C | Ω/km | 5000 |
| Min. insulation resistance at 20°C | MΩ·km | 1000 |
| Dielectric withstanding voltage | V/min. | 500 |
| Unaged elongation | %(min) | 200 |
| Unaged tensile strength | kg/mm ² | 1.78 |
| Flammability | — | VW-1 |
| Max current | A | 0.40 |
| Characteristic impedance (at D-TDR) | Ohm | 50 ± 5 Ω |

PIN ASSIGNMENT:

| | | | | | | | | | | | | | | | | | | | | |
|-------|------|------|------|------|------|------|------|------|------|------|------|------|------|------|------|------|------|------|------|------|
| CN1 | 1 | 2 | 3 | 4 | 5 | 6 | 7 | 8 | 9 | 10 | 11 | 12 | 13 | 14 | 15 | 16 | 17 | 18 | 19 | 20 |
| CN2 | 20 | 19 | 18 | 17 | 16 | 15 | 14 | 13 | 12 | 11 | 10 | 9 | 8 | 7 | 6 | 5 | 4 | 3 | 2 | 1 |
| COLOR | BLUE | BLUE | BLUE | BLUE | BLUE | BLUE | BLUE | BLUE | BLUE | BLUE | BLUE | BLUE | BLUE | BLUE | BLUE | BLUE | BLUE | BLUE | BLUE | BLUE |
| WIRE | 40# | 40# | 40# | 40# | 40# | 40# | 40# | 40# | 40# | 40# | 40# | 40# | 40# | 40# | 40# | 40# | 40# | 40# | 40# | 40# |
| ohm | 50Ω | 50Ω | 50Ω | 50Ω | 50Ω | 50Ω | 50Ω | 50Ω | 50Ω | 50Ω | 50Ω | 50Ω | 50Ω | 50Ω | 50Ω | 50Ω | 50Ω | 50Ω | 50Ω | 50Ω |

NOTES:

- 1.Dimension Shall Be Interpreted Per ASME Y14.5M-2018.
- 2.Electrical Test:
 - 2.1;100% OPEN & SHORT TEST.
 - 2.2;Conductor Resistance:≤2.0Ω
 - 2.3;Insulation Resistance:DC 200V/10MΩ
 - 2.4;Withstanding Voltage:AC 100V/0.1S/0.5mA
- 3.△Is the change point

| | | | | |
|-----|-----------|--|-----|------|
| 4 | UV | UV Glue | A/R | G |
| 3 | SHELL | ACES P/N:51496-MB2P-020 PLUG&U-BAR ASSEMBLY | 2 | PCS |
| 2 | CONNECTOR | ACES P/N:51496-0202P-001 0.4 PITCH LVDS VERTICAL TYPE PLUG | 2 | PCS |
| 1 | WIRE | COAXIAL UL1354 40AWG COLOR:BLUE OD:0.35mm 50Ω VW-1 | A/R | mm |
| NO. | Name | Product Name | Qty | Unit |

| | | | | |
|---------------------------------------|-------------|------------|-------------------------------|------------------|
| QUALITY SYMBOLS | DRAWN BY | DATE | | |
| MAJOR Ⓢ | Luyao.liu | 2023/08/03 | | |
| CRITICAL Ⓢ | CHECKED BY | DATE | 51496-20Pin LVDS cable | |
| GENERAL TOLERANCES (UNLESS SPECIFIED) | Dyan xu | 2023/08/03 | | |
| | APPROVED BY | DATE | SIZE | RFO NO. |
| | Ocean li | 2023/08/03 | A4 | |
| 300以上 ±5 | UNITS | | SCALE | PART NO. |
| 101-300 ±3 | mm | | Free | 30-5738-302HF-FA |
| 31-100 ±2 | SCALE | | SHEET NO. | DWG NO. |
| 0-30 ±1 | Free | | 10F2 | |
| ANGLES ±5° | | | REV | |
| | | | A | |

RoHS 2.0+HF

| REV. | DESCRIPTION | DESIGN | DATE |
|------|---------------|-----------|------------|
| A | First Drawing | Luyao.Liu | 2023/08/03 |

Packing



LVDS cable

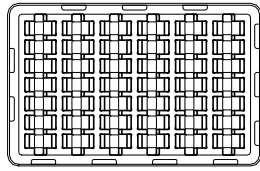

Tray(42Pcs)

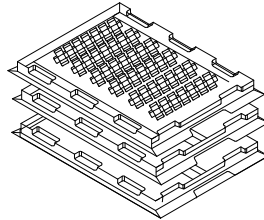

Tray(50Layer)

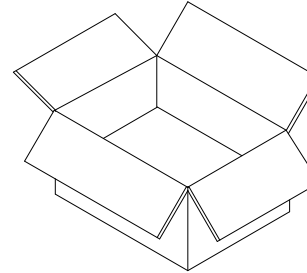

Carton

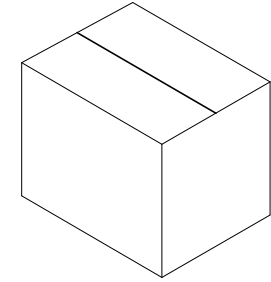

2100Pcs/Carton

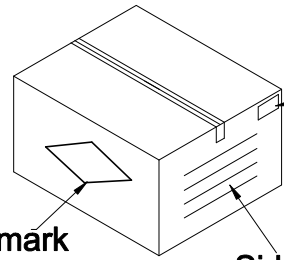

Label

Front mark

Side mark

PACKING:

- 1.Product weight:0.6±10%g
- 2.42Pcs/Tray,50 Layer/Carton,2100Pcs.
- 3.Carton size:450*300*300mm

| | | | | |
|--|-----------------------|--------------------|---|------------------------------|
| QUALITY SYMBOLS MAJOR Ⓜ CRITICAL Ⓢ GENERAL TOLERANCES (UNLESS SPECIFIED) 300以上 ±5 101~300 ±3 31~100 ±2 0~30 ±1 ANGLES ±5° | DRAWN BY Luyao.liu | DATE 2023/08/03 | ACES ELECTRONICS TITLE 51496-20Pin LVDS cable | |
| | CHECKED BY Dyan xu | DATE 2023/08/03 | | |
| | UNITS mm | | SIZE A4 | RFO NO. |
| | SCALE Free | SHEET NO. 20F2 | REV A | PART NO. 30-5738-302HF-FA |
| | | | | DWG NO. |