

## Product Release/ LVDS Conn

P/N	Description	Mating Height (mm)	Circuits
50473 series	0.5mm Pitch LVDS Coax. Rcpt. Conn. SMT S/R S/T Type	1.00mm	20/30/40/50

### Features

- Current: 100V, 0.5A, AC/DC (per pin)
- Mating Force: 1.63Kg Max.
- UnMating Force: 0.4Kg Min.
- Mated with: 50384
- Application: Notebook/Panel/Tablet PC

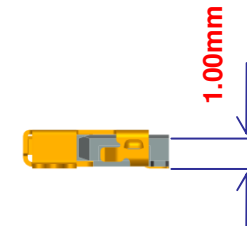
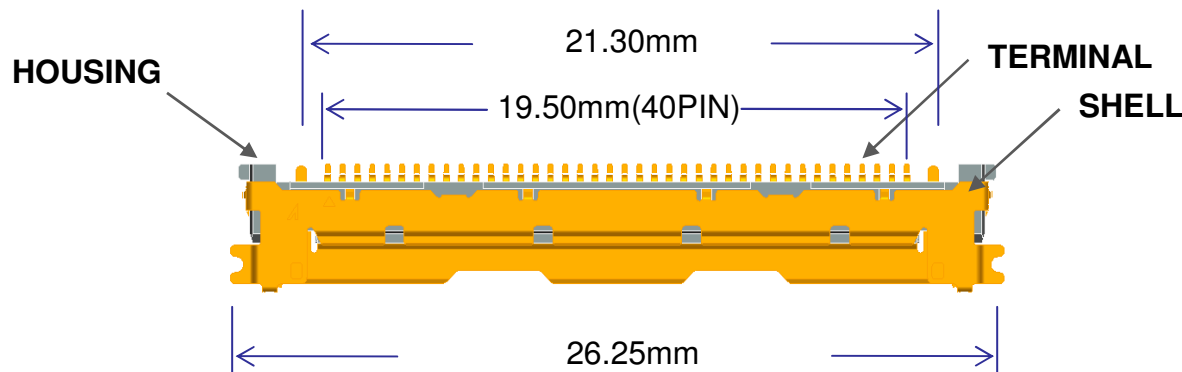

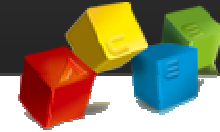

## Product Release/ LVDS Conn

P/N	Description	Mating Height (mm)	Circuits
50384 series	0.5mm Pitch LVDS Coax. Plug Conn. S/R S/T Type	1.0mm	20/30/40/50

### Features

- Current: 100V, 0.5A, AC/DC (per pin)
- Mating Force: 1.63Kg Max.
- UnMating Force: 0.4Kg Min.
- Mated with: 50473
- Application: Notebook/Panel/Tablet PC

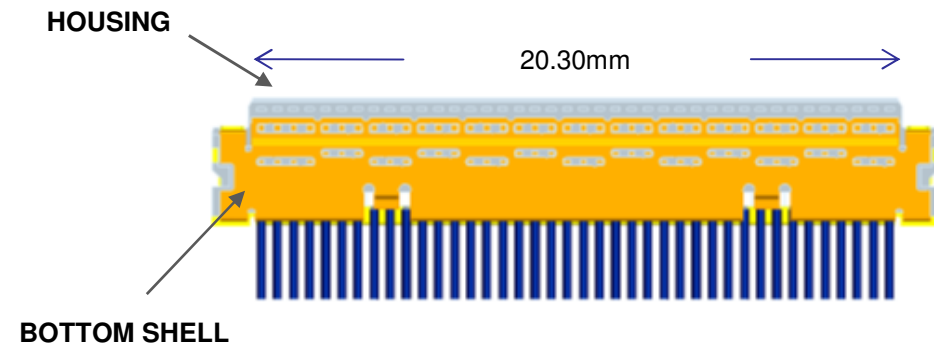
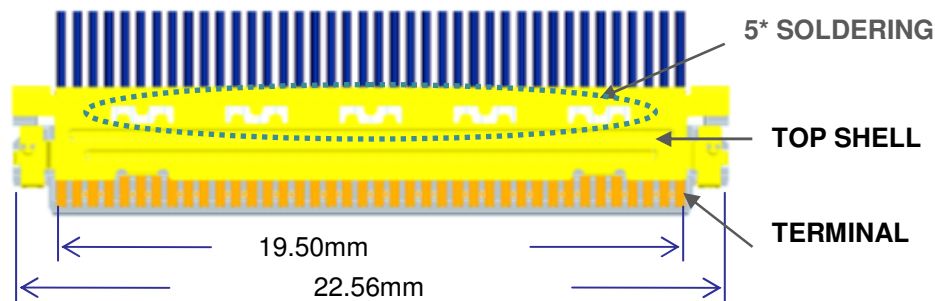
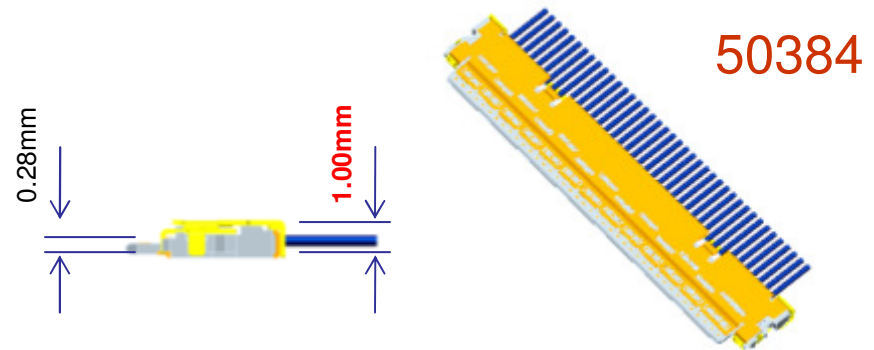

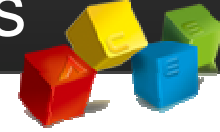

### Product Release/ **LVDS Conn**

